

# Origami Hund mit Zeitung 1 von 6

Copyright © www.orime.de 2011 Dominik Meißner

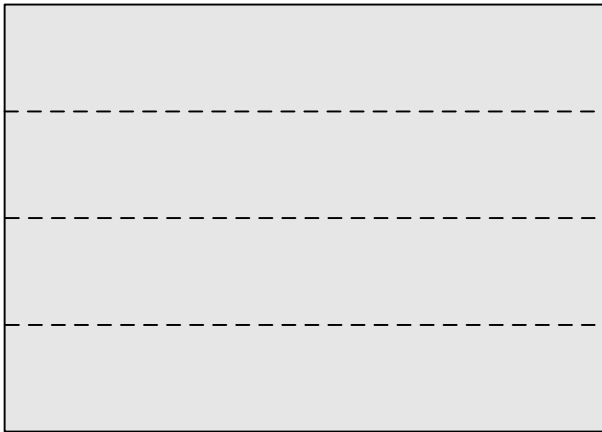

1 Zeitung (newspaper)



2 Nur einen Streifen (only one stripe)

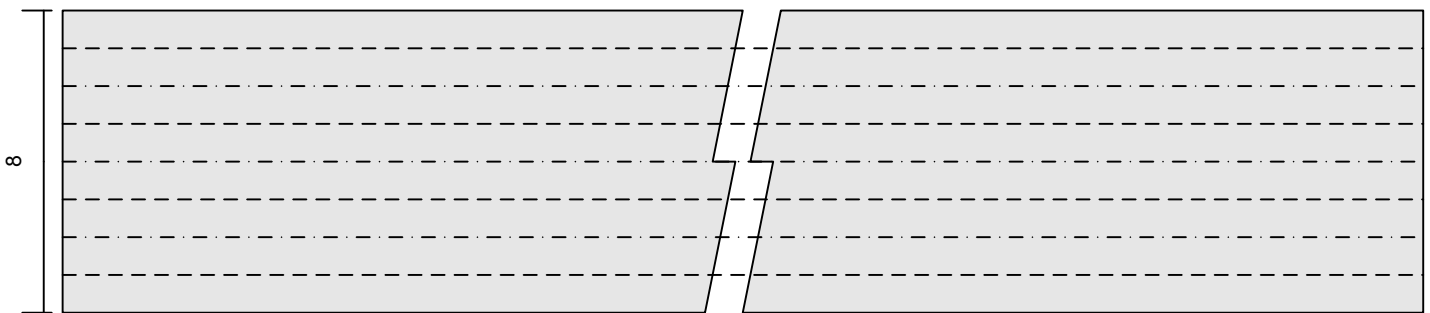

3



4

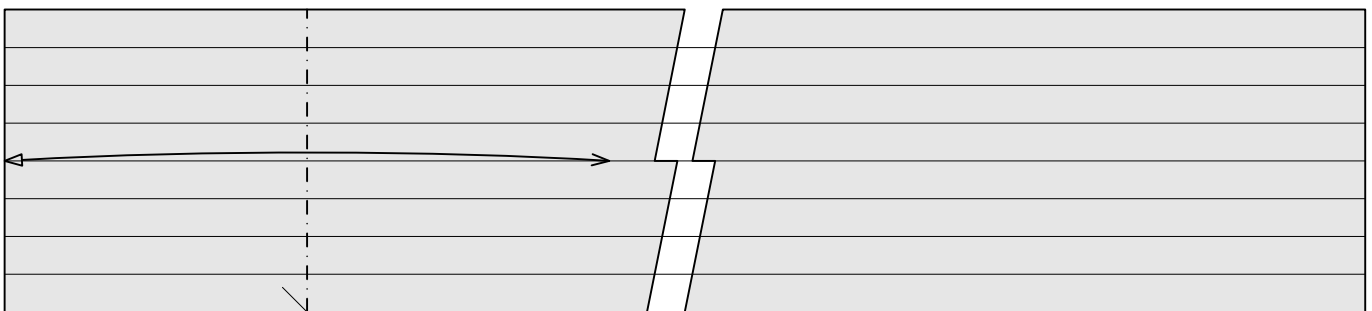

5

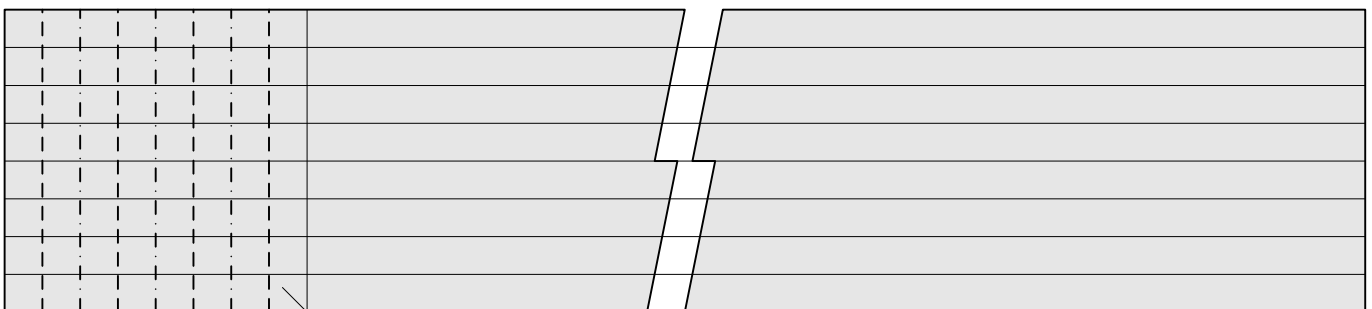

6

# Origami Hund mit Zeitung 2 von 6

Copyright © www.orime.de 2011 Dominik Meißner

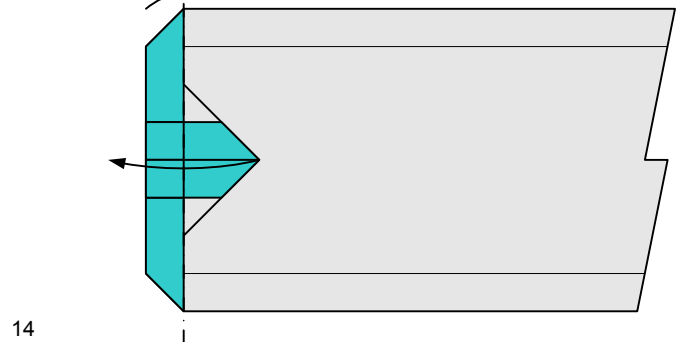
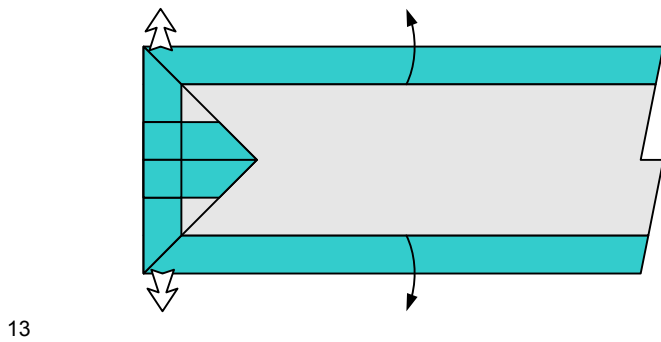
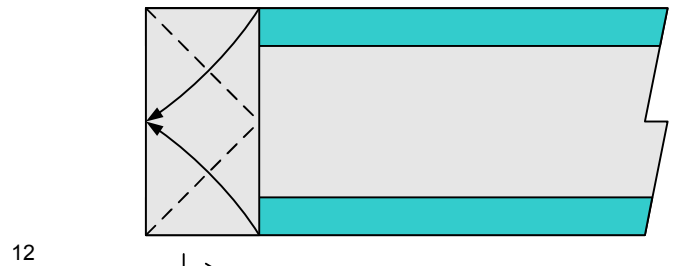
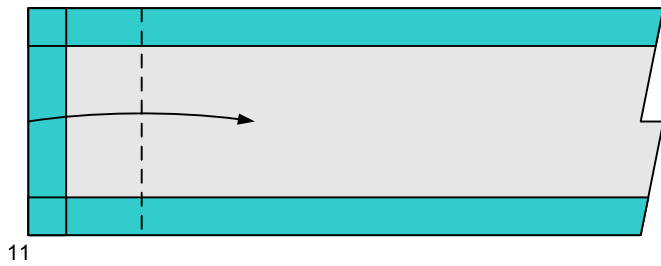
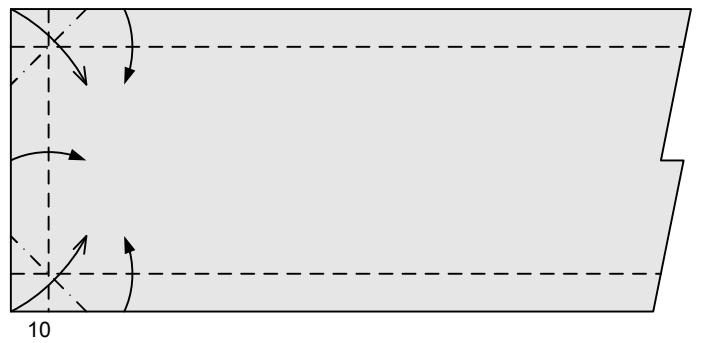
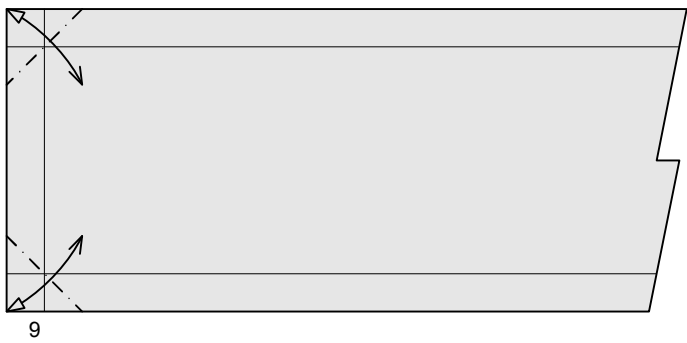
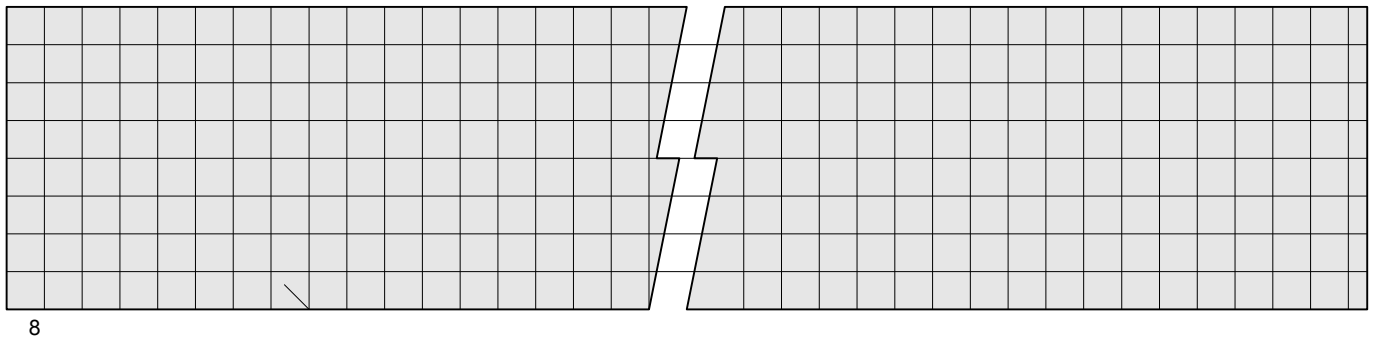
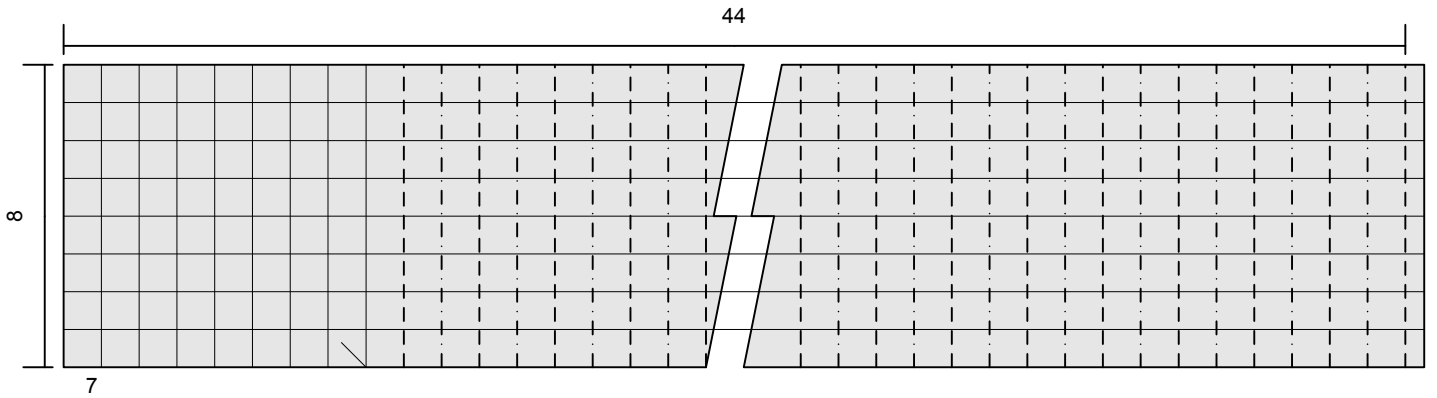

# Origami Hund mit Zeitung 3 von 6

Copyright © www.orime.de 2011 Dominik Meißner

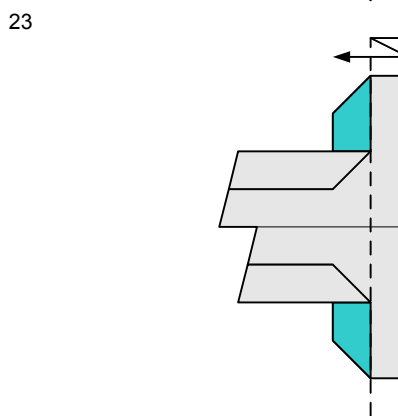
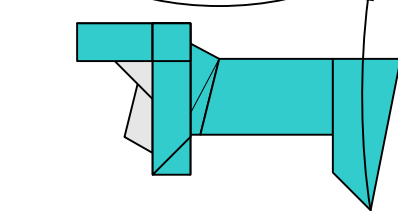
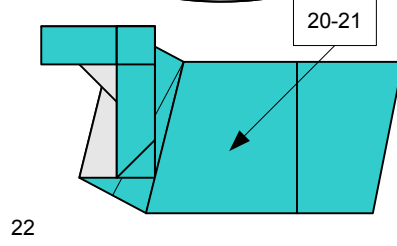
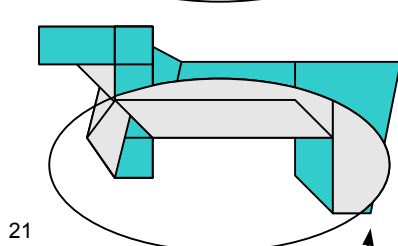
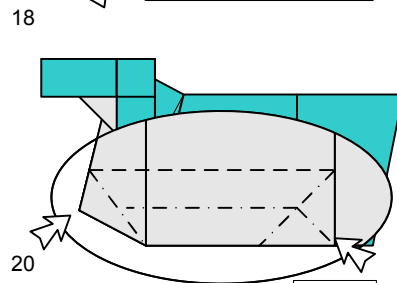
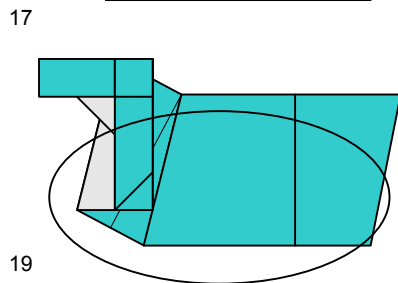
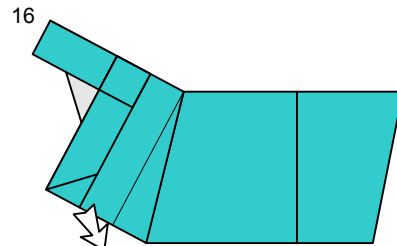
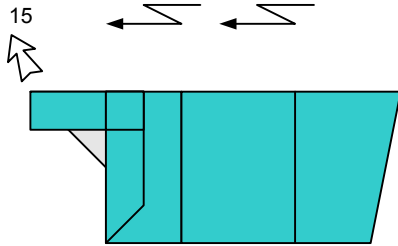
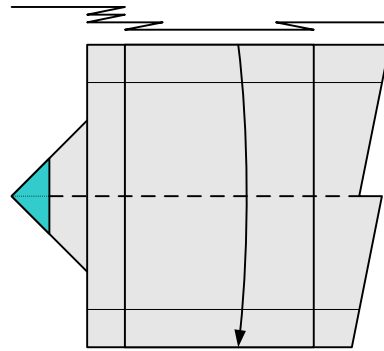
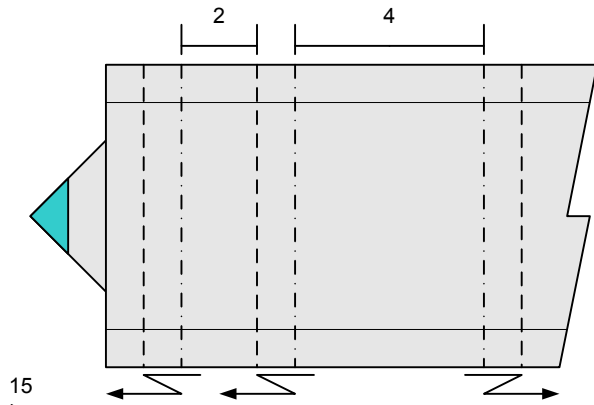

24

# Origami Hund mit Zeitung 4 von 6

Copyright © www.orime.de 2011 Dominik Meißner

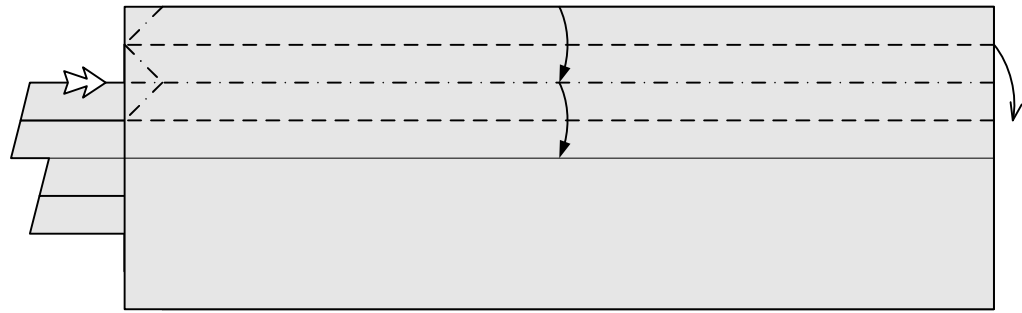

25

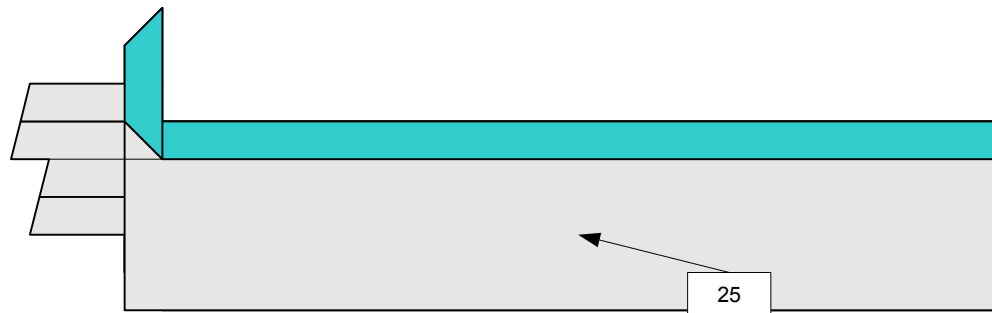

26

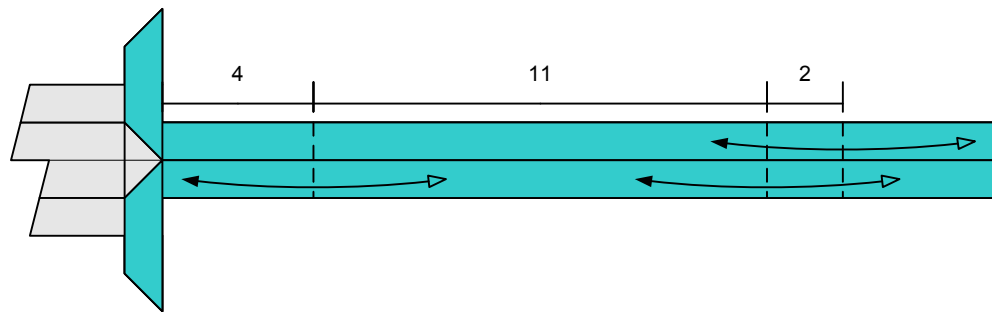

27

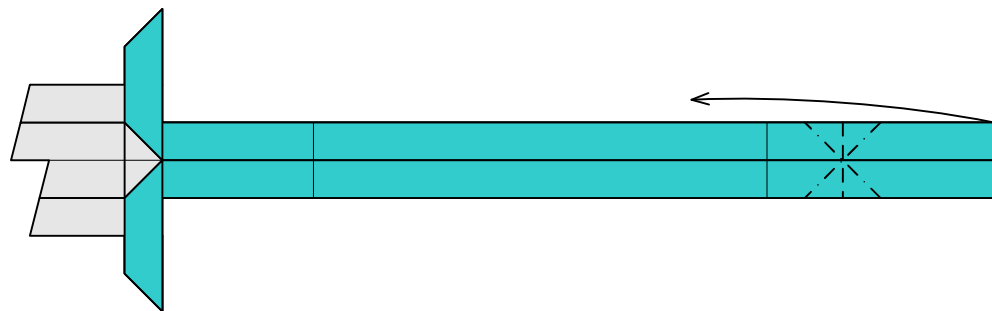

28

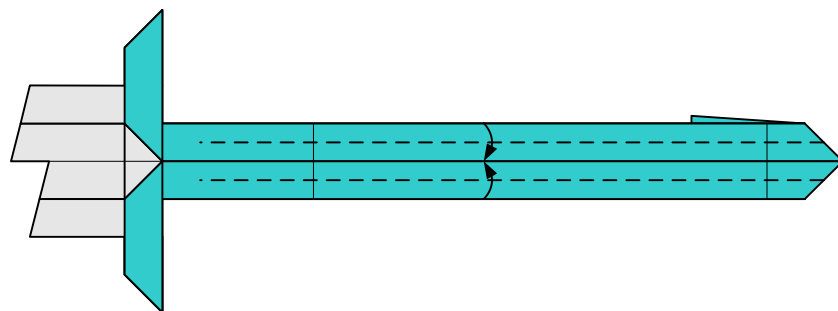

29

# Origami Hund mit Zeitung 5 von 6

Copyright © www.orime.de 2011 Dominik Meißner

30

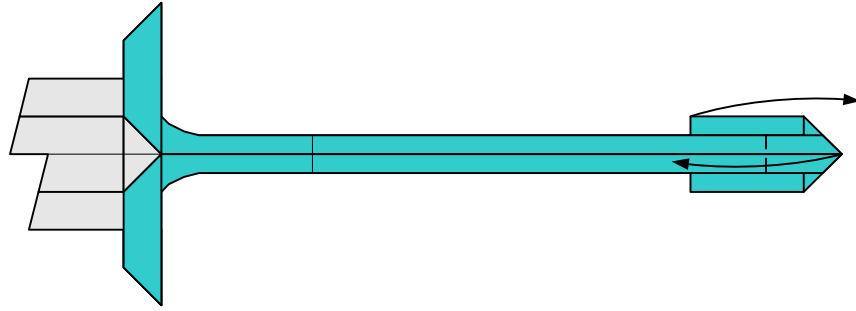

31

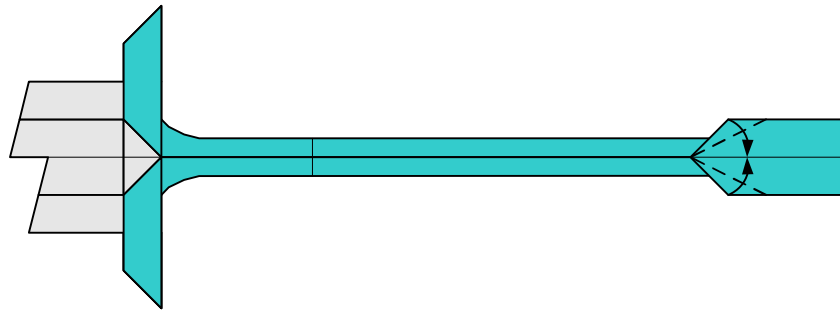

32

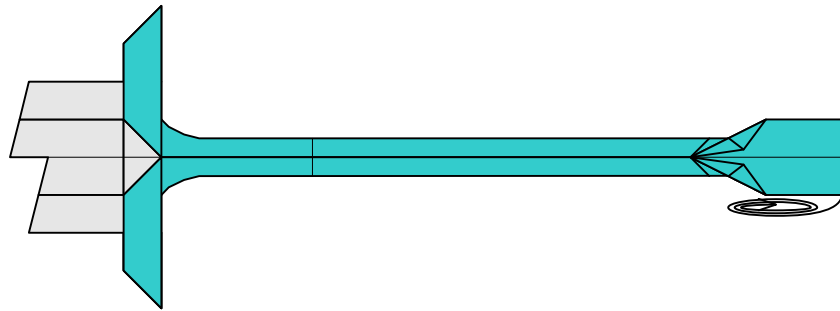

33

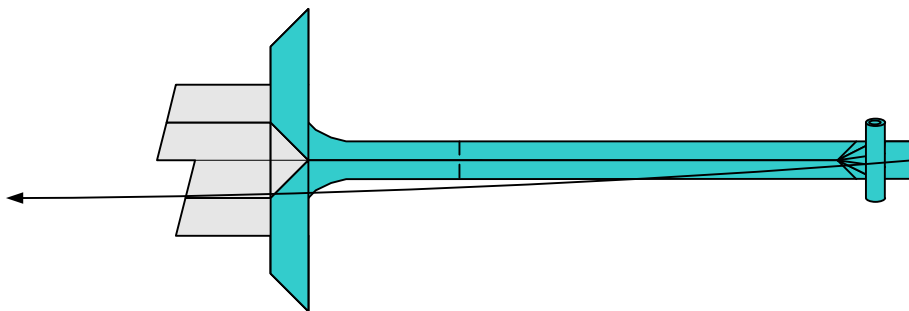

# Origami Hund mit Zeitung 6 von 6

Copyright © www.orime.de 2011 Dominik Meißner

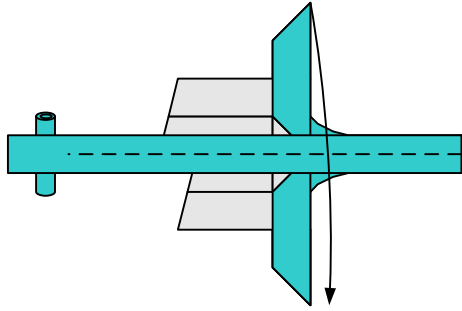

34

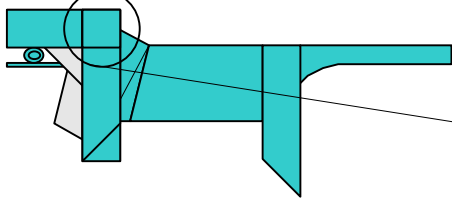

35

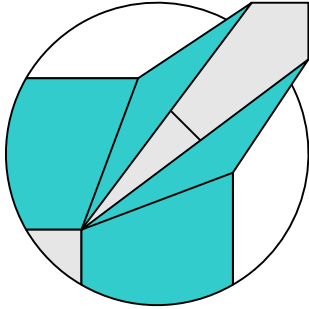

37

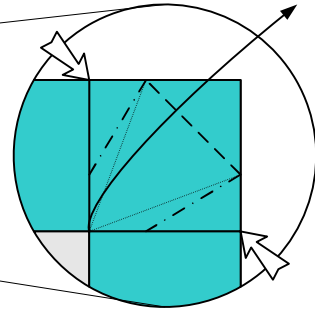

37

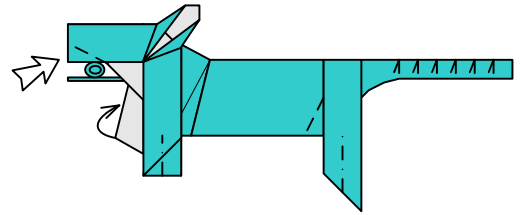

38

